



Motorized Pulley 138LS

Power packed drive for high duty conveyors

Product Description

The motorized pulley 138LS is a very flexible component thanks to the wide range of powers and speeds.

Characteristics

- Salt water resistant aluminum bearing housing
- Induction motor three phases alternating current
- Dual power supply
- Integral motor protection
- Steel- hardened helical spur gear
- Low noise operation
- Maintenance free
- Lifetime lubrication
- Reversible operation
- Reinforced shaft for RL greater than 800 mm

Applications

- Conveyors for heavy and frequent use
- Conveyors for transportation of packages
- Logistics applications
- Check-in desks at airports
- Conveyors for furniture manufacture
- Manufacturing of food processes
- Modular belts, steel or plastic applications
- Dry, damp and frequent wash down applications

Technical data	
Motor data	
Type of Motor	Asynchronous squirrel-cage, IEC 34 (VDE 0530)
Insulation class of motor windings	Class F, IEC 34 (VDE 0530)
Derated windings (20% power reduction)	On request for applications without belt
Voltage	230/400 V \pm 5% (IEC 34/38) Special voltage on request
Frequency	50/60 Hz
Internal shaft sealing system	Double-lipped FPM or nitrile rubber, NBR
Protection rate	IP66
Thermal protection	Bimetallic Contact
Ambient temperature, 3-phase motor	-25 to +40 °C
General technical data	
Max. Roller length (RL)	1800 mm

All data and values declared in the catalogue refer to operation with a frequency of 50 Hz.



Motorized Pulley 138LS

Power packed drive for high duty conveyors



Materials

The following Motorized Pulley components are available in different versions, as shown in the below chart, with further options for the material type as indicated.

Components	Version	Material				
		Aluminium	Steel	Stainless steel	Brass/Nickel	Polymer
Shell	Crowned		Std	TS8N		
	Cylindrical		Std	TS8N		
	Cylindrical + key (for sprockets)		Std	TS8N		
	Special crowns and grooves		Std	TS8N		
End housing	Standard	Std		TS8N		
	With V-grooves		Std	TS8N		
	With O-grooves		Std	TS8N		
	With chain sprockets		Std	TS8N		
Shaft	Standard		Std	TS8N		
	Cross-drilled and threaded, M8		Std	TS8N		
Electrical connection	Straight connector			TS8N	Std	
	Elbow connector			TS8N		Std
	Terminal box	Std		TS8N		

Please contact Rulmeca for further versions.

TS8N Version - End Caps in stainless steel with PTFE lip seals.

Options

- Rubber Lagging for standard belts
- Profiled lagging for plastic modular belts
- Profiled lagging for thermoplastic belts
- Sprockets for plastic modular belts
- Backstop / Anti run-back bearing
- Electromagnetic brake
- Rectifiers
- Encoder
- Food-grade Oil (EU, FDA and USDA)
- Non-horizontal mounting (more than $\pm 5^\circ$)
- TS8N with mild steel shell is possible

Note: The combination of encoder and electromagnetic brake is not possible.

Accessories

- Mounting brackets
- Idler Pulleys
- Rollers for conveyors
- Frequency Converters



Motorized Pulley 138LS

Power packed drive for high duty conveyors

Technical data for Motorized pulley 138LS - 3 phase - 50Hz

Rated power [kW]	Poles n.	Gear stages n.	Gear ratio i	Rated speed of the shell [m/s]	Rated revolutions of the shell [min ⁻¹]	Rated torque of Motorized pulley [Nm]	Rated tangential force [N]	Max. belt tension T1+T2 [N]	Min. length RL [mm]	
0,10	12	3	78,40	0,04	5,6	159	2295	8300	300	
			66,00	0,05	6,7	138	1990			
			52,96	0,06	8,3	111	1600			
0,18	8	3	29,56	0,10	14,9	62	895	8300	300	
			66,00	0,08	10,2	163	2350			
		52,96	0,10	12,7	131	1890				
		43,65	0,13	15,5	108	1555				
0,24	6	3	29,56	0,16	22,8	73	1050	8300	300	
			25,20	0,20	26,8	62	890			
		66,00	0,10	13,9	163	2350				
		52,96	0,13	17,4	131	1890				
		43,65	0,16	21,1	108	1555				
0,37	6	3	29,56	0,20	31,1	73	1050	8300	300	
			20,22	0,32	45,5	50	720			
	25,20	0,25	36,5	62	890					
	66,00	0,13	18,0	168	2425					
	52,96	0,16	21,2	153	2205					
	43,65	0,25	32,1	104	1500					
	29,56	0,32	47,4	70	1010					
	25,20	0,40	55,6	60	865					
0,55	4	3	20,22	0,50	69,2	48	690	4850	300	
			16,67	0,63	84,0	40	575			
			12,44	0,80	112,5	30	430			
		77,41	0,25	35,3	152	2190				
		66,00	0,32	41,4	129	1860				
		52,96	0,40	51,5	104	1500				
		43,65	0,50	62,5	86	1240				
0,75	2	3	29,56	0,63	92,4	58	835	4850	300	
			25,20	0,80	108,3	49	705			
		20,22	1,00	135,0	40	575				
		16,67	1,25	163,8	33	475				
	4	2	12,44	1,60	219,5	24	345			3650
			32,59	0,32	41,9	159	2295			
		25,20	0,40	54,2	127	1830				
		20,22	0,50	67,5	102	1470				
0,75	2	2	16,67	0,63	81,9	84	1210	4850	320	
			25,20	0,80	112,9	67	965			
			20,22	1,00	140,7	54	775			
			16,67	1,25	170,7	44	635			
			12,44	1,60	228,7	33	475			

Motorized Pulley 138LS

Power packed drive for high duty conveyors



Technical data for Motorized Pulley 138LS - 3 phase - 50Hz

Rated power [kW]	Poles n.	Gear stages n.	Gear ratio i	Rated speed of the shell [m/s]	Rated revolutions of the shell [min ⁻¹]	Rated torque of Motorized pulley [Nm]	Rated tangential force [N]	Max. belt tension T1+T2 [N]	Min. length RL [mm]
1,0	2	3	43,65	0,50	64,4	145	2090	4850	350
			32,59	0,63	86,2	109	1570		
		2	25,20	0,80	111,5	84	1210	3650	
			20,22	1,00	139,0	67	965		
			16,67	1,25	168,6	56	805		
			12,44	1,60	225,9	41	590		

Standard weight for Motorized pulley 138LS

Rated power [kW]	Poles n.	Standard weight [kg] for standard RL [mm]													
		300	320	350	400	450	500	550	600	650	700	750	800	900	1000
0,10	12	14,0	14,5	15,0	16,0	17,0	18,0	19,0	20,0	21,5	23,0	24,0	25,0	27,0	29,0
0,18	8	14,0	14,5	15,0	16,0	17,0	18,0	19,0	20,0	21,5	23,0	24,0	25,0	27,0	29,0
0,24	6	14,0	14,5	15,0	16,0	17,0	18,0	19,0	20,0	21,5	23,0	24,0	25,0	27,0	29,0
0,37	6	---	15,0	15,6	16,5	17,5	18,5	19,5	20,5	22,0	23,5	24,5	25,5	27,5	29,5
	4	14,0	14,5	15,0	16,0	17,0	18,0	19,0	20,0	21,5	23,0	24,0	25,0	27,0	29,0
0,55	2	14,0	14,5	15,0	16,0	17,0	18,0	19,0	20,0	21,5	23,0	24,0	25,0	27,0	29,0
0,75	4	---	15,0	15,6	16,5	17,5	18,5	19,5	20,5	22,0	23,5	24,5	25,5	27,5	29,5
	2	---	15,0	15,6	16,5	17,5	18,5	19,5	20,5	22,0	23,5	24,5	25,5	27,5	29,5



Motorized Pulley 138LS

Power packed drive for high duty conveyors

Cable Specification

Available cable options:

- Standard, screened
- Standard, unscreened
- Halogen-free, screened
- Halogen-free, unscreened

Available lengths: 1 / 3 / 5 m.

Min.Length with option

The following options increase the minimum length of the motorized pulley.

Option	RL min. with option mm
Brake	RL min. + 50 mm
Encoder SKF	RL min. + 0 mm
Encoder RLS	RL min. + 50 mm

Motorized Pulley 138LS

Power packed drive for high duty conveyors

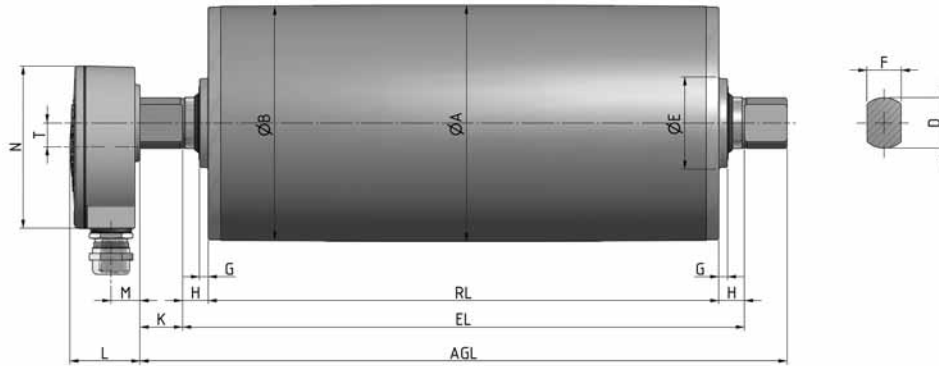

Motorized pulley standard version with Terminal Box in aluminium.

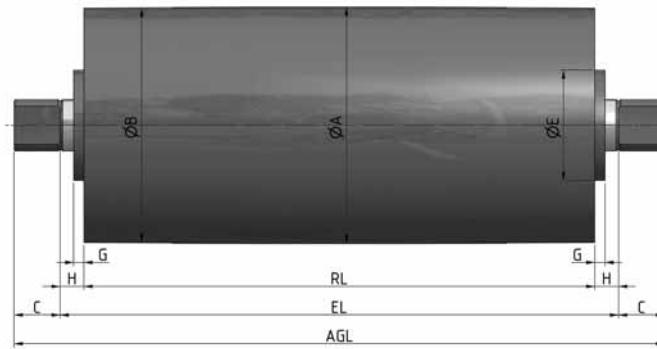

Idler Pulley in stainless steel (TS8N).

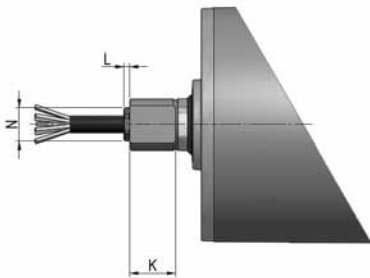

Straight connector in brass or stainless steel.

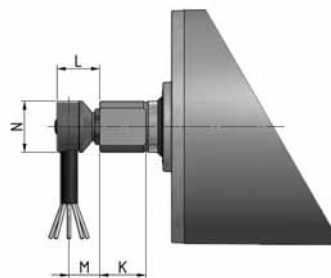

Elbow connector in stainless steel.

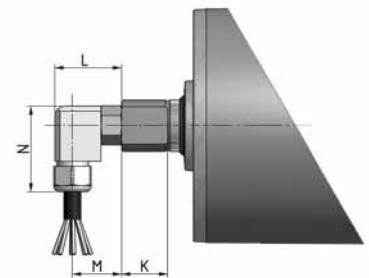

Elbow connector in polyamide.

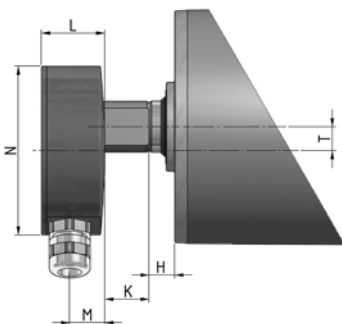

Terminal box in stainless steel.

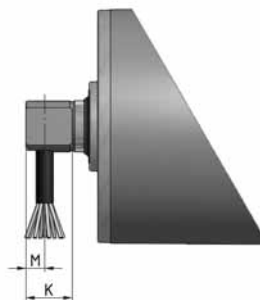

Cable connector 90° with threaded shaft.

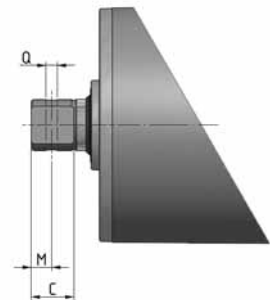

Shaft, cross-drilled and threaded.



Motorized Pulley 138LS

Power packed drive for high duty conveyors

Type/Option	A mm	B mm	C mm	D mm	E mm	F mm	G mm	H mm	K mm	L mm	M mm	N mm	Q mm	T mm
Motorized pulley 138LS Standard version with Terminal Box in Aluminium	138,5	137	25	30	54	20	5	15	25	41	17	95		14
Terminal Box in Stainless steel									25	37	20,5	99		14
Idler Pulley in stainless steel (TS)					64,5		6		27					
Straight connector in brass or stainless steel									27	3,5		19,5		
Elbow connector in stainless steel									27	25	18	30		
Elbow connector in Polyamide									27	39	29	50		
Cable Connector 90° with threaded shaft									27		8-11			
Cross-drilled and threaded shaft									27		12		M8	